

Article number: 2310431019

Description: E+G Levelling elements  
LX.25-SW13-M8X72

## Measures

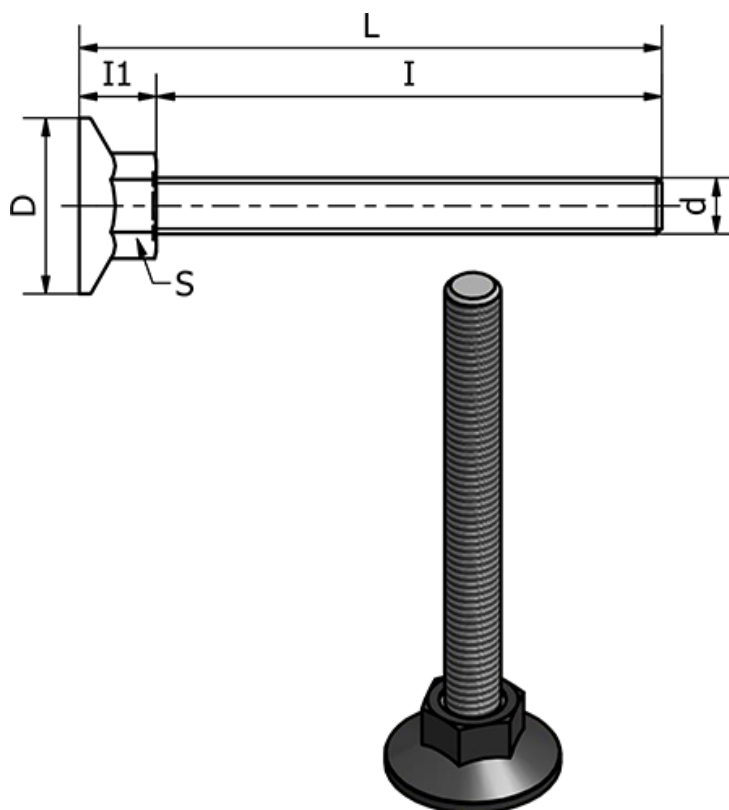

d	= M8
D	= 25
I	= 72
I1	= 11
L	= 83
S	= 13
Static load in (N)	= 2500
Type	= Forzinket

Weight (g) = -